HD Series



HD Series



HD10 Series **40**



HD30/HDP20 Series **46**

HD Series

HD10 Series



HD16-9-16S

HD10-3-96P



HD14-9-16P

HD16-3-96S

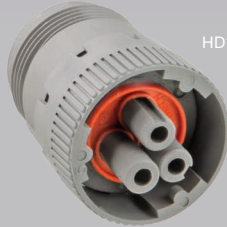

- Environmentally sealed – IP68, IP6K9K, when installed to manufacturer's specifications.
- Cylindrical thermoplastic design.
- Available either in-line or flanged.
- Quick connect/disconnect bayonet coupling.
- Resistant to most fluids in industrial applications.
- Commonly used for diagnostic applications.
- Available in kits containing all components required to make both sides of a connection.

Housing :	Thermoplastic
Seal :	Silicone Rubber
Shock :	50G
Vibration :	20G rms 10 – 2000Hz
Approvals :	20mm Flame Test per Standard UL-94
Ingress Protection :	IP68, IP6K9K
Operating Temperature :	-55°C to 125°C

Part Numbering System

HD 10 - 9 - 96 P E - B009

Series Prefix :
HD Series – **HD**

Connector Style :
Square Flange Receptacle – **10**

In-line Receptacle – **14**

Plug – **16**

Shell Size / Number of Cavities :

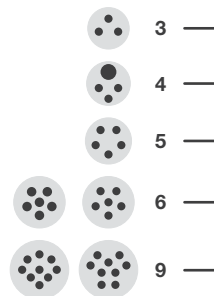

Special Modifications :

- blank** – No modification.
- B009** – No standard keying. No rear thread.
- B010** – Standard coupling ring. Only for HD16-6-12S.

For a complete list of special modifications see page 115–119

Wire Seal Options :

- blank** – Normal. For use with standard insulation wire.
- E** – Extra thin. Designed specifically for Extra thin wall wire.

Contact Type :

- P** – Pins
- S** – Sockets

Insert Arrangement :

- 4, 12, 96, 1939** – Threaded Rear
- 16** – Non-Threaded Rear



Shell Size / Number of Cavities

HDXX-3-16/3-96-XX

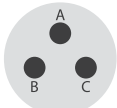

3 x size 16
E

HDXX-4-4-XX

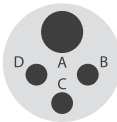

1 x size 4,
3 x size 16

HDXX-5-16-XX

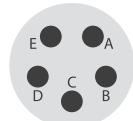

5 x size 16

HDXX-6-12-XX

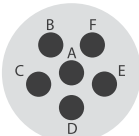

6 x size 12

HDXX-6-96-XX

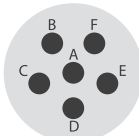

6 x size 16

HDXX-9-16-XX

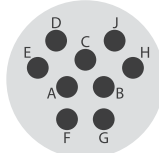

9 x size 16

HDXX-9-96-XX

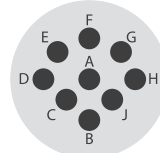

9 x size 16

E

For details on contacts & further options see page 98

Popular HD10 Series Special Modification

B009

Raised keying removed from front of receptacle flange.
No rear thread.

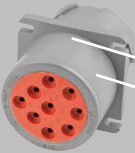

HD10-9-96P-B009
No raised keying.
No rear thread.



Standard
HD10-9-96P

B010 (exclusive to the HD16-6-12S)

The HD16-6-12S does not come with the standard HD10 coupling ring.
If the standard HD10 coupling ring is required order the HD16-6-12S-B010.

The B010 part number suffix **only** applies to HD16-6-12S

HD16-6-12S-B010
Standard coupling ring.

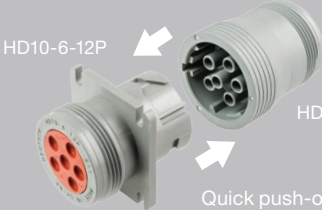

HD10-6-12P
HD16-6-12S

Quick push-on/pull-off.
No twist action required.

HD16-6-12S
No coupling ring.
Push-on/pull-off design for use where non-permanent, quick connect/disconnect is required.

For a complete list of special modifications see page 115-119



HD Series

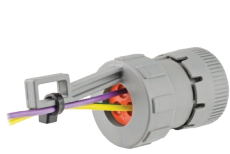

HD18-003

HD18-006

HD18-009



HDC14-3

HDC14-6

HDC14-9



HDC16-3

HDC16-5

HDC16-6

HDC16-9



HD10-3BT



HD10-9BT



HDB30-18



HD30-18-BT



HD10-9-GKT



JDL082397

HD10 Series – Accessories

Part No.	Description	Shell Size	Suits
HD18-003	Strain Relief	3	All HD10 Series
HD18-006	Strain Relief	6	All HD10 Series
HD18-009	Strain Relief	9	All HD10 Series
HDC14-3	Protective Cap	3	Plugs
HDC14-6	Protective Cap	6	Plugs
HDC14-9	Protective Cap	9	Plugs
HDC16-3	Protective Cap	3	Receptacles
HDC16-5	Protective Cap	5	Receptacles
HDC16-6	Protective Cap	6	Receptacles
HDC16-9	Protective Cap	9	Receptacles
HD10-3BT	Insulator – Grey – 80mm	3	All HD10 Series
HD10-9BT	Insulator – Grey – 80mm	9	All HD10 Series
HDB30-18	Insulator – Grey – 150mm	6 & 9	All HD10 Series
HD30-18-BT	Insulator – Grey – 80mm	6 & 9	All HD10 Series
HD10-9-GKT	Mounting Gasket	9	Flange Receptacles
JDL082397	Lanyard	9	All HD10 Series & all Protective Caps

Newsletter

Receive the latest ionnic news and updates via email, sign up
ionnic.com/product-updates.html

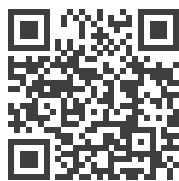
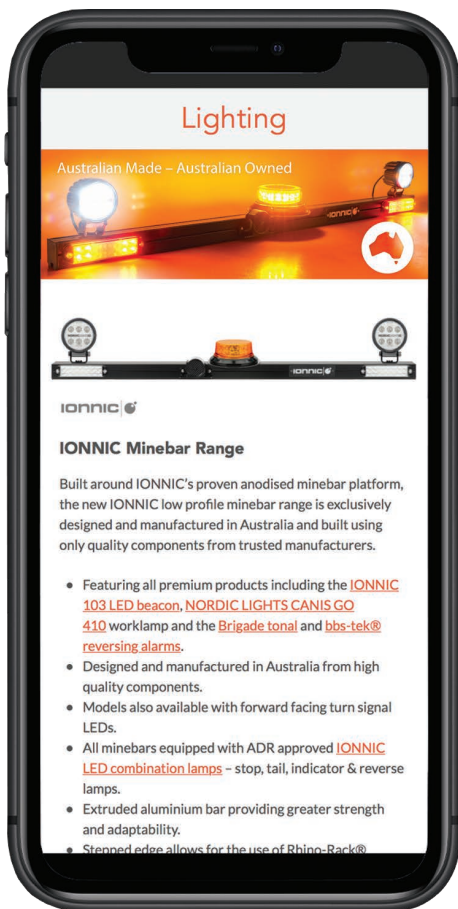

ionnic.com

ionnic | Product Update Newsletter Lighting | Safety | Electrical April 2023

Safety



BRIGADE

Backsense® Network Radar with OSD Kit

Brigade's Backsense® Network Radar System is the next generation of radar-based obstacle detection. Due to the number of complex blind spots on a vehicle, a single radar cannot always provide the detection required and numerous in-cab displays for multiple radars can be more of a distraction than a benefit.

The Brigade Backsense® Network Radar with OSD Kit allows for the use of 2 Backsense® Network Radar sensors to be combined with any Brigade Backeye® camera system.

Radar detection data is overlaid transparently along the edge of the monitor so as not to obscure the camera image, with the audible warning via the monitor speakers.

- Overlay detection data for up to 2 radar sensors on a single monitor.
- Complies with CAN 2.0A Base Frame Format.
- Detects multiple moving and stationary objects.
- High frequency continuous wave provides increased reliability & low false alarm rates.
- Adjustable detection range up to 30m.
- 3 trigger inputs used for activating components such as alarms and beacons.
- Environmentally sealed sensor – IP69K
- Sensor can be steam & pressure cleaned.
- Multi-voltage.
- 3 year warranty.

Electrical



ionnic | 

HD Series

HD10 Series Kits

Kits contain all components required to make both sides of a connection.

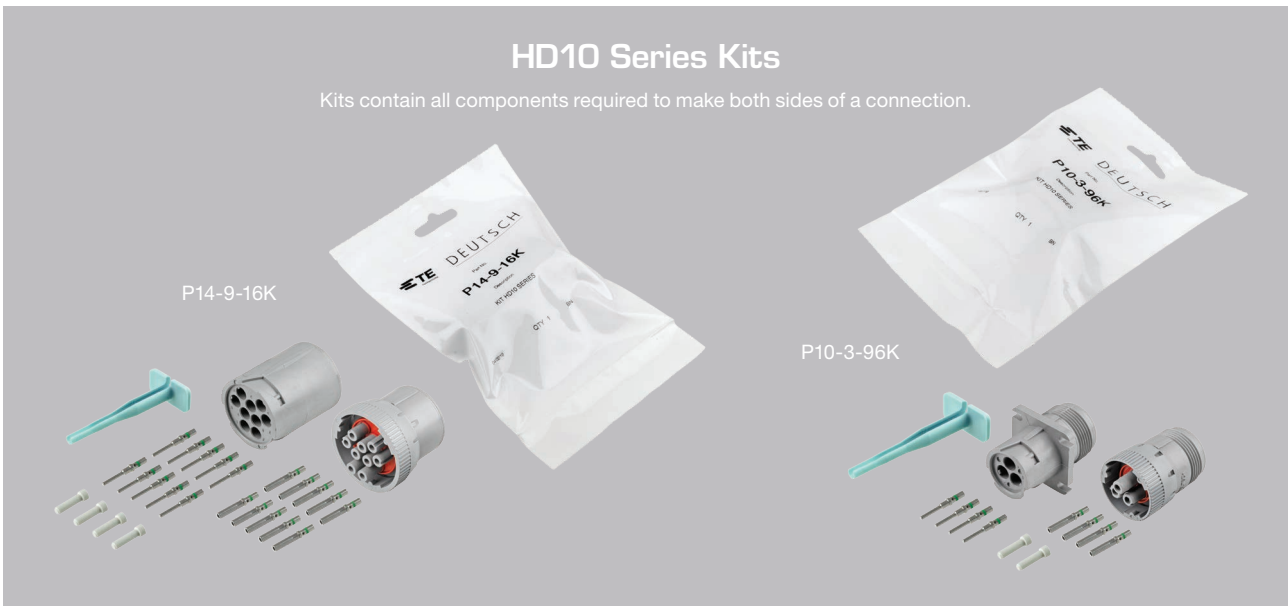

HD10 Series Kit Numbering System

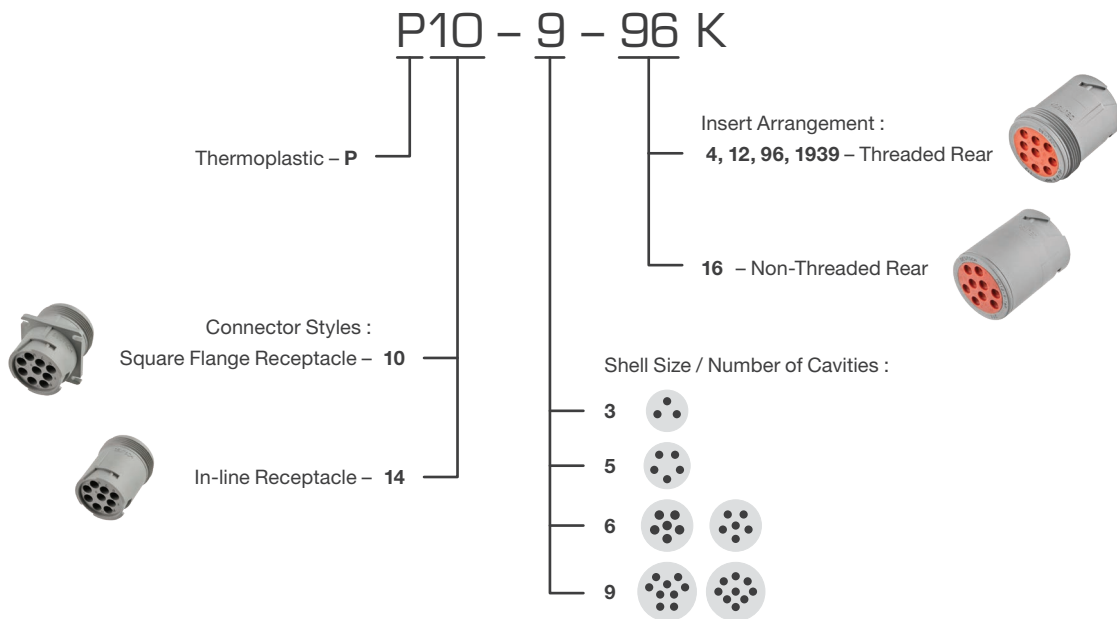

1939 Special Modification

The P10-9-1939K kit contains connectors with the 1939 modification, keyed and with a black housing.



HD10 Series Kits

	Wire Seal	Threaded Rear	Receptacle	Part No.	Kit Contents
 <p>3 x size 16</p>	Normal	Threaded Rear	Square Flange	P10-3-96K	1 x Receptacle (HD10-3-96P) 1 x Plug (HD16-3-96S) 4 x Pin – Solid (0460-215-16141) 4 x Socket – Solid (0462-209-16141) 1 x Removal Tool (0411-310-1605) 2 x Cavity Plug (114017)
		Threaded Rear	In-line	P14-3-96K	1 x Receptacle (HD14-3-96P) 1 x Plug (HD16-3-96S) 4 x Pin – Solid (0460-215-16141) 4 x Socket – Solid (0462-209-16141) 1 x Removal Tool (0411-310-1605) 2 x Cavity Plug (114017)
 <p>5 x size 16</p>	Normal	Non-Threaded Rear	Square Flange	P10-5-16K	1 x Receptacle (HD10-5-16P) 1 x Plug (HD16-5-16S) 6 x Pin – Solid (0460-215-16141) 6 x Socket – Solid (0462-209-16141) 1 x Removal Tool (0411-310-1605) 4 x Cavity Plug (114017)
		Non-Threaded Rear	In-line	P14-5-16K	1 x Receptacle (HD14-5-16P) 1 x Plug (HD16-5-16S) 6 x Pin – Solid (0460-215-16141) 6 x Socket – Solid (0462-209-16141) 1 x Removal Tool (0411-310-1605) 4 x Cavity Plug (114017)
 <p>6 x size 12</p>	Normal	Threaded Rear	Square Flange	P10-6-12K	1 x Receptacle (HD10-6-12P) 1 x Plug (HD16-6-12S) 7 x Pin – Solid (0460-204-12141) 7 x Socket – Solid (0462-203-12141) 1 x Removal Tool (114010) 4 x Cavity Plug (114017)
 <p>6 x size 16</p>	Normal	Threaded Rear	Square Flange	P10-6-96K	1 x Receptacle (HD10-6-96P) 1 x Plug (HD16-6-96S) 7 x Pin – Solid (0460-215-16141) 7 x Socket – Solid (0462-209-16141) 1 x Removal Tool (114010) 4 x Cavity Plug (114017)
 <p>9 x size 16</p>	Normal	Non-Threaded Rear	Square Flange	P10-9-16K	1 x Receptacle (HD10-9-16P) 1 x Plug (HD16-9-16S) 10 x Pin – Solid (0460-215-16141) 10 x Socket – Solid (0462-209-16141) 1 x Removal Tool (0411-310-1605) 4 x Cavity Plug (114017)
		Non-Threaded Rear	In-line	P14-9-16K	1 x Receptacle (HD14-9-16P) 1 x Plug (HD16-9-16S) 10 x Pin – Solid (0460-215-16141) 10 x Socket – Solid (0462-209-16141) 1 x Removal Tool (0411-310-1605) 4 x Cavity Plug (114017)
 <p>9 x size 16</p>	Normal	Threaded Rear	Square Flange	P10-9-96K	1 x Receptacle (HD10-9-96P) 1 x Plug (HD16-9-96S) 10 x Pin – Solid (0460-215-16141) 10 x Socket – Solid (0462-209-16141) 1 x Removal Tool (0411-310-1605) 4 x Cavity Plug (114017)
		Threaded Rear	In-line	P14-9-96K	1 x Receptacle (HD14-9-96P) 1 x Plug (HD16-9-96S) 10 x Pin – Solid (0460-215-16141) 10 x Socket – Solid (0462-209-16141) 1 x Removal Tool (0411-310-1605) 4 x Cavity Plug (114017)
	Extra Thin	Threaded Rear	Square Flange	P10-9-1939K	1 x Receptacle (HD10-9-1939PE) 1 x Plug (HD16-9-1939SE) 10 x Pin – Solid (0460-215-16141) 10 x Socket – Solid (0462-209-16141) 1 x Removal Tool (0411-310-1605) 4 x Cavity Plug (114017)



HD Series

HD30/HDP20 Series



- Environmentally sealed – IP67, when installed to manufacturer’s specifications.
- Designed specifically for the truck, bus, mining and construction industry.
- Available in aluminium (HD30) or thermoplastic housings (HDP20).
- Multiple pin configurations that accept contact sizes 4 through 20.
- Quick connect/disconnect bayonet coupling.
- HD30 and HDP20 series are cross compatible.
- Resistant to most fluids in industrial applications.
- Available in kits containing all components required to make one side of a connection.

Housing :	HD30	Aluminium
	HDP20	Thermoplastic
Seal :		Silicone Rubber
Shock :		50G
Vibration :		20G rms 10 – 2000Hz
Approvals :	20mm Flame Test per Standard UL-94	
Ingress Protection :		IP67
Operating Temperature :		-55°C to 125°C

Part Numbering System

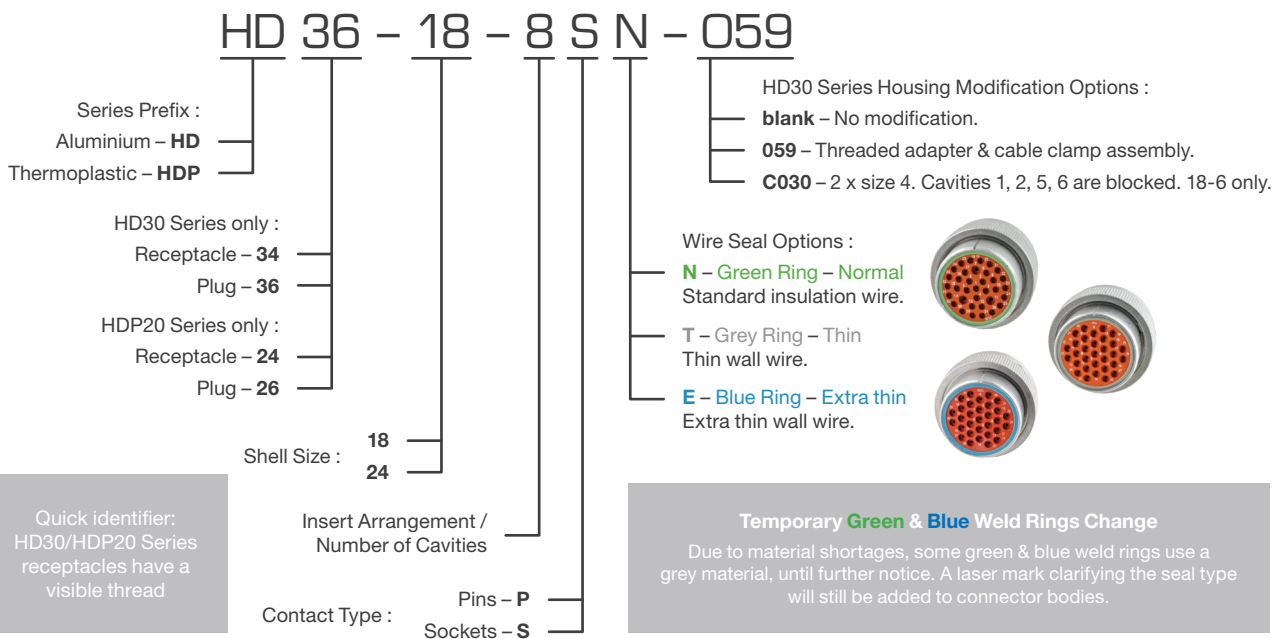

Recommended Wire Insulation O.D.

Contact Size	N – Normal Seal – Green Ring		T – Thin Seal – Grey Ring		E – Extra Thin Seal – Blue Ring	
	Inches	mm	Inches	mm	Inches	mm
20	0.040 – 0.095	1.02 – 2.41	0.040 – 0.095	1.02 – 2.41	0.040 – 0.095	1.02 – 2.41
16	0.100 – 0.134	2.54 – 3.40	0.088 – 0.134	2.23 – 3.40	0.053 – 0.120	1.35 – 3.05
12	0.134 – 0.170	3.40 – 4.32	0.113 – 0.170	2.87 – 4.32	0.097 – 0.158	2.46 – 4.01
8	0.190 – 0.240	4.83 – 6.10	0.170 – 0.240	4.32 – 6.10	0.135 – 0.220	3.43 – 5.59
4	0.280 – 0.292	7.11 – 7.42	0.261 – 0.292	6.63 – 7.42	0.261 – 0.292	6.63 – 7.42

Undersized wire insulation is a major cause of contaminant ingress.

Shell Size 18 Arrangements

<p>HDXX-18-6-XX</p> <p>2 x size 4, 4 x size 16 N, E</p>	<p>HDXX-18-8-XX</p> <p>8 x size 12 N, E</p>	<p>HDXX-18-14-XX</p> <p>14 x size 16 N, T, E</p>	<p>HDXX-18-20-XX</p> <p>2 x size 16, 18 x size 20 N, E</p>	<p>HDXX-18-21-XX</p> <p>21 x size 20 N</p>
---	---	--	--	--

Shell Size 24 Arrangements

<p>HDXX-24-9-XX</p> <p>1 x size 4, 2 x size 8, 6 x size 12 N, E</p>	<p>HDXX-24-14-XX</p> <p>1 x size 4, 1 x size 12, 12 x size 16 N, E</p>	<p>HDXX-24-16-XX</p> <p>16 x size 12 N, E</p>	<p>HDXX-24-18-XX</p> <p>1 x size 8, 3 x size 12, 14 x size 16 N, E</p>	
<p>HDXX-24-19-XX</p> <p>6 x size 12, 13 x size 16 N, E</p>	<p>HDXX-24-21-XX</p> <p>4 x size 12, 17 x size 16 N, E</p>	<p>HDXX-24-23-XX</p> <p>23 x size 16 N, T, E</p>	<p>HDXX-24-29-XX</p> <p>4 x size 12, 19 x size 16, 6 x size 20 E</p>	<p>HDXX-24-31-XX</p> <p>31 x size 16 T, E</p>
<p>HDXX-24-33-XX</p> <p>33 x size 20 N</p>	<p>HDXX-24-35-XX</p> <p>3 x size 16, 32 x size 20 N, E</p>	<p>HDXX-24-47-XX</p> <p>5 x size 16, 42 x size 20 E</p>	<p>HDXX-24-91-XX</p> <p>2 x size 8, 2 x size 12, 5 x size 16 N, E</p>	

For complete details on contacts & further options see page 98



HD Series

Popular HD30 Series Special Modifications

HD34-18-8SN-XXX



Standard – no modification

Provides mechanical protection to wire entering connector as well as additional strain relief

2 x size 4 cavities. 18-6 only. Cavities 1, 2, 5, & 6 are blocked

blank – no modification

059 – Threaded adapter & cable clamp assembly

C030 – 18-6 only. 2 x size 4 cavities. 4 x size 16 cavities blocked (1, 2, 5, 6)

For a complete list of special modifications see page 115-119

HD30/HDP20 Series Dimensions

HDXXX-XX-8SN

18 – Shell Size

24 – Shell Size

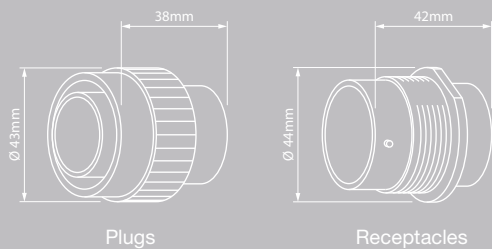

Plugs

Receptacles

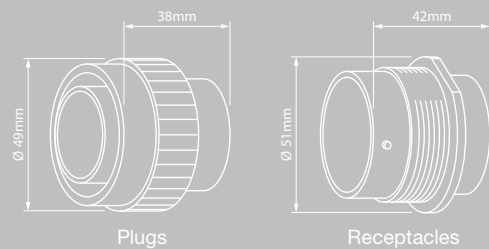

Plugs

Receptacles

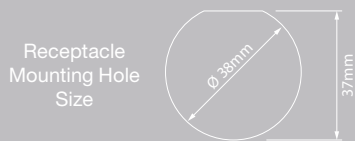

Receptacle Mounting Hole Size

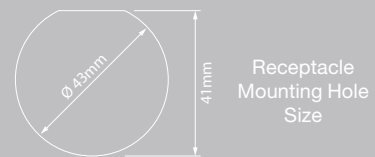

Receptacle Mounting Hole Size

Temporary Material Change

Due to material shortages, some HD30/HDP20 series connectors will use a black material instead of the orange for the pin front component, until further notice.

UL re-certification on the connectors is in process.



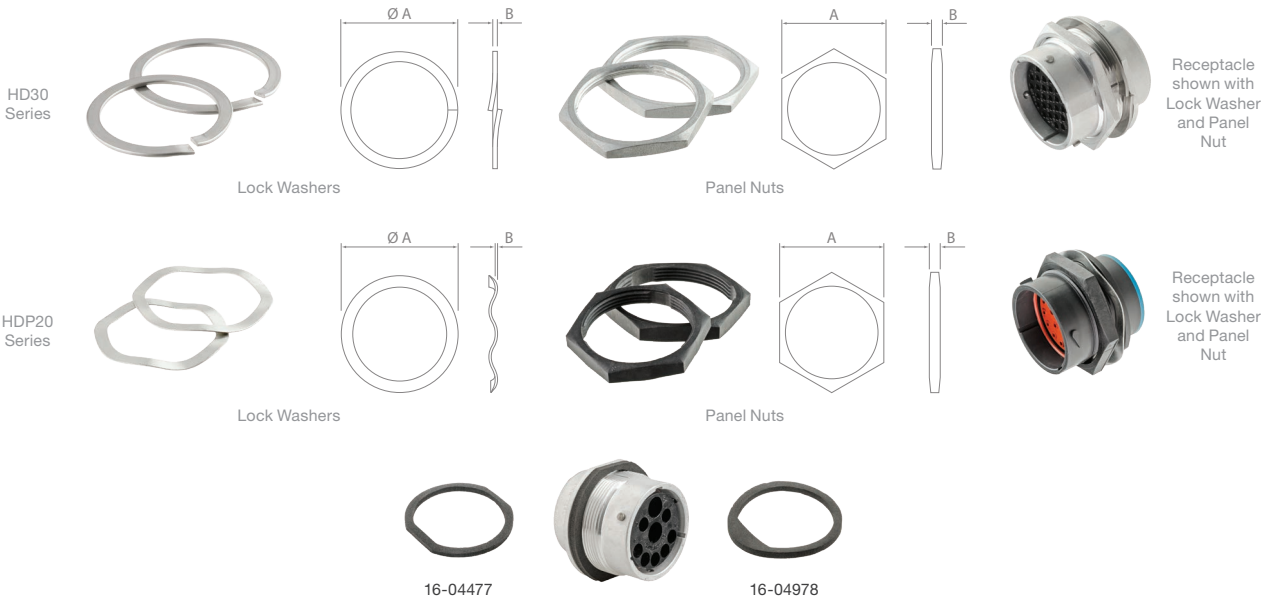

HD30/HDP20 Series – Washers, Nuts & Gaskets

Part No.	Description	Shell Size	Suits	A (mm)	B (mm)
114021	Lock Washer	18	HD30 Series	47.90	1.57
112264	Lock Washer	24	HD30 Series	52.68	1.57
114020-90	Panel Nut	18	HD30 Series	42.80	4.52
112263-90	Panel Nut	24	HD30 Series	47.63	4.52
2414-002-1886	Lock Washer – Wave	18	HDP20 Series	47.90	0.51
2414-001-2486	Lock Washer – Wave	24	HDP20 Series	52.68	0.51
2411-002-1805	Panel Nut – Thermoplastic	18	HDP20 Series	42.80	6.35
2411-001-2405	Panel Nut – Thermoplastic	24	HDP20 Series	47.63	6.35
16-04978	Mounting Gasket – Neoprene	18	HD30/HDP20 Series – Receptacles		
16-04477	Mounting Gasket – Neoprene	24	HD30/HDP20 Series – Receptacles		



HD30/HDP20 Series – Protective Caps

Part No.	Material	Shell Size	Suits
HDC26-18	Thermoplastic	18	HDP20 Series – Receptacles
HDC26-24	Thermoplastic	24	HDP20 Series – Receptacles
HDC34-18	Aluminium	18	HD30 Series – Plugs
HDC34-24	Aluminium	24	HD30 Series – Plugs
HDC36-18	Aluminium	18	HD30 Series – Receptacles
HDC36-24	Aluminium	24	HD30 Series – Receptacles



HD Series

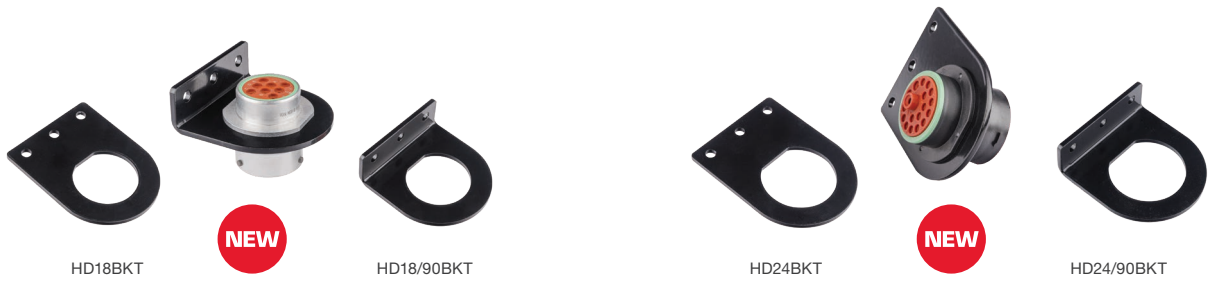

HD30/HDP20 Series – Mounting Brackets NEW

Part No.	Mounting	Shell Size
HD18BKT	Flat	18
HD18/90BKT	90°	18
HD24BKT	Flat	24
HD24/90BKT	90°	24

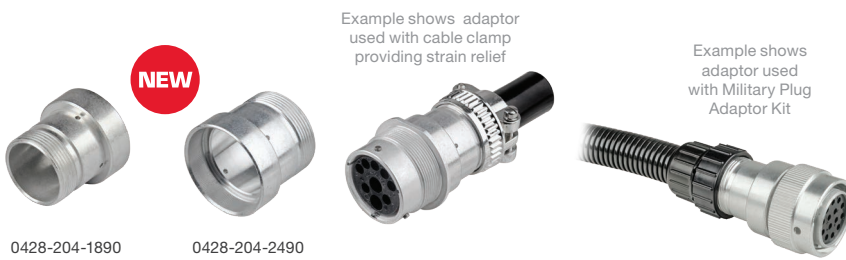

Attaches to rear of an HD30 Series plug or receptacle providing a thread.

Used to adapt HD30 Series connectors to Cable Clamps (0409-201-1800 & 0409-201-2400) or Schlemmer Military Plug Adaptor Kits (SF04 & SF05).

Press-fit application. Requires press.

HD30 Series – Adaptors NEW

Part No.	Shell Size
0428-204-1890	18
0428-204-2490	24

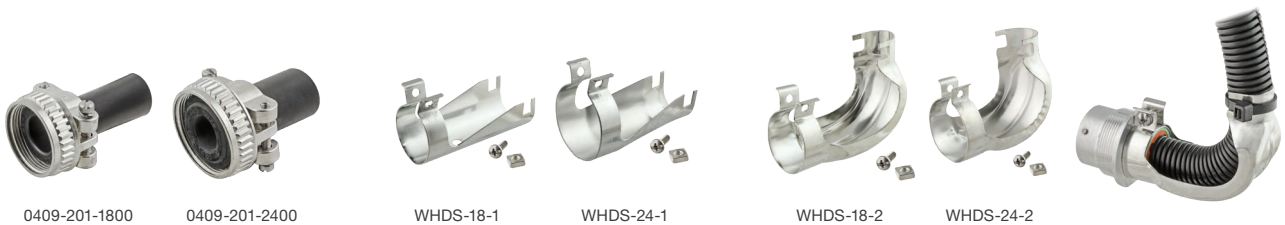

HD30/HDP20 Series – Strain Relief

Part No.	Description	Orientation	Shell Size
0409-201-1800	Cable Clamp	Straight	18
0409-201-2400	Cable Clamp	Straight	24
WHDS-18-1	Backshell	Straight	18
WHDS-24-1	Backshell	Straight	24
WHDS-18-2	Backshell	90°	18
WHDS-24-2	Backshell	90°	24



HD30/HDP20 Series – Insulators/Boots

Part No.	Description	Shell Size
HD30-18-BT	Grey – 80mm	18
HDB30-18	Grey – 150mm	18
HD30-24BT-BK	Black – 80mm	24
HDB30-24	Black – 120mm	24
HD30-24BT-90-BK	Black – 80mm – 90°	24

The D hole punch is a hand tool used to cut D shaped holes into steel, aluminium, plastic and other material. The D shaped hole allows the connector to be securely mounted and helps prevent the connector from spinning.

- **Punchable Material:** Up to 1.98mm mild steel or aluminium. Up to 4.76mm plastic, wood, paneling, or other soft material.
- **Tool Material:** A2 material heat treated to a Rockwell hardness of 60 to 62.
- **Tool Size:** (approx. dimensions) L140mm x H50mm x D50mm
- **Sharpening:** The tool can be sharpened as needed.
- **Usability:** A 15.87mm minimum pilot hole is required to accommodate the draw stud. Air tools can be used.

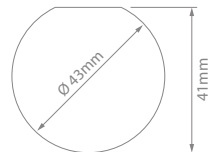
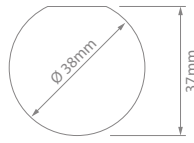

NEW

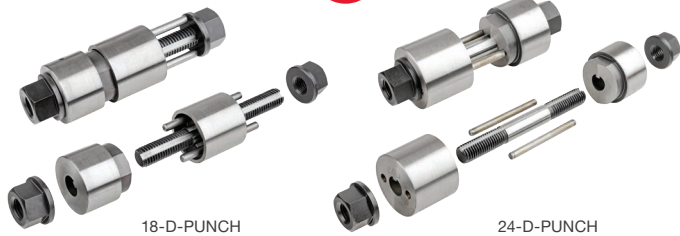

HD30/HDP20 Series – D Hole Punch NEW

Part No.	Shell Size
18-D-PUNCH	18
24-D-PUNCH	24



HD Series

HD30/HDP20 Series Half Kits

Kits contain all components required to make one side of a connection.



HD30/HDP20 Half Kit Numbering System

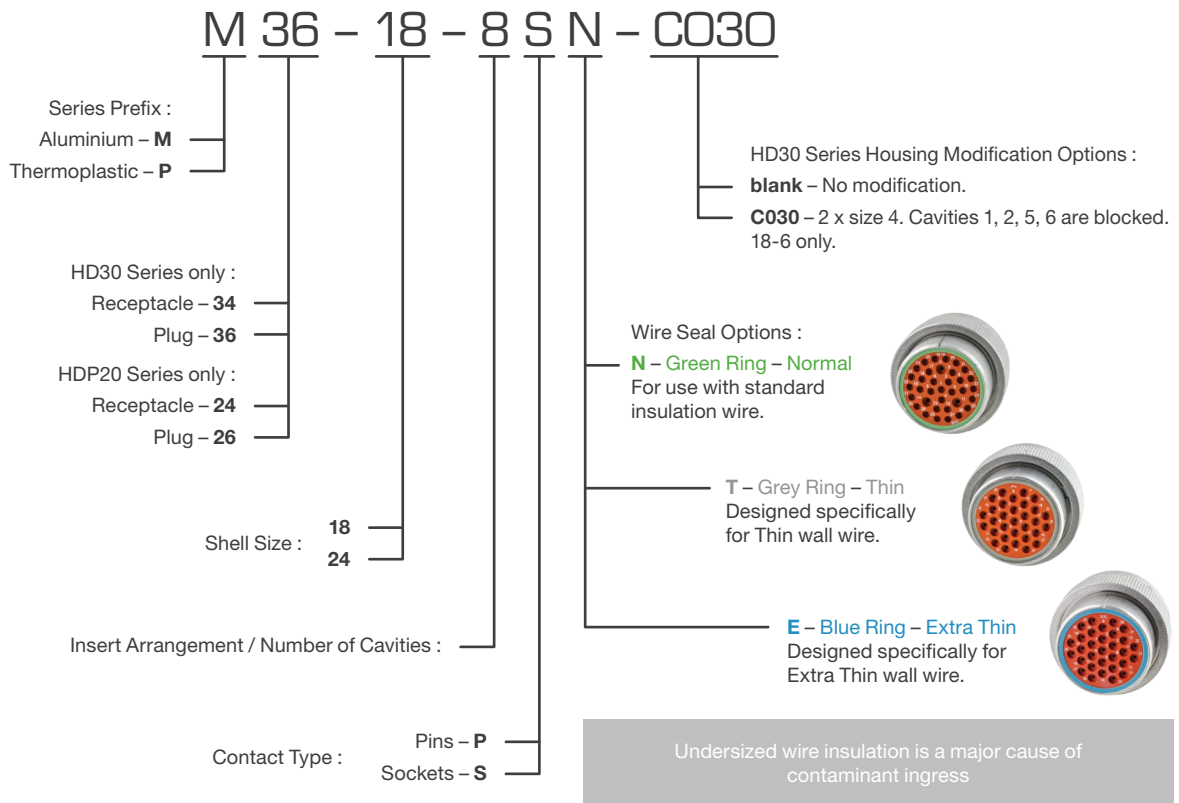

Quick Receptacle Identifier

You can quickly determine if a HD30/HDP20 Series connector is a receptacle or plug by checking for visible threads.

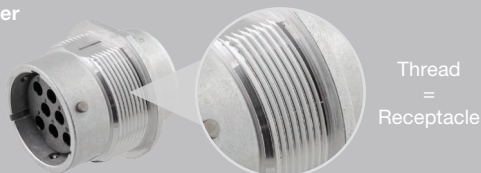

Temporary Green & Blue Weld Rings Change

Due to material shortages, some green & blue weld rings use a grey material, until further notice. A laser mark clarifying the seal type will still be added to connector bodies.

HD30/HDP20 Half Kits – Shell Size 18 – 6 Cavities

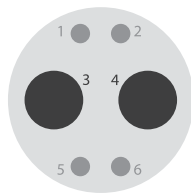

2 x size 4
4 x size 16
Cavities 1, 2, 5, 6 are blocked

Connector	Wire Seal	Part No.	Kit Contents
Aluminium Receptacle	Green Ring (Normal)	M34-18-6PN-C030	1 x Receptacle (HD34-18-6PN-C030) 1 x Removal Tool (114009) 2 x Pin – Solid (0460-204-0490) 1 x Panel Nut (114020-90) 1 x Lock Washer (114021)
Aluminium Plug	Green Ring (Normal)	M36-18-6SN-C030	1 x Plug (HD36-18-6SN-C030) 1 x Removal Tool (114009) 2 x Socket – Solid (0462-203-04141)

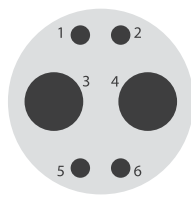

2 x size 4
4 x size 16

Thermoplastic Receptacle	Green Ring (Normal)	P24-18-6PN	1 x Receptacle (HDP24-18-6PN) 1 x Removal Tool (114009) 1 x Removal Tool (0411-310-1605) 2 x Pin – Solid (0460-204-0490) 4 x Pin – Solid (0460-215-16141) 1 x Panel Nut (2411-002-1805) 1 x Lock Washer (2414-002-1886)
Thermoplastic Plug	Green Ring (Normal)	P26-18-6SN	1 x Plug (HDP26-18-6SN) 1 x Removal Tool (114009) 1 x Removal Tool (0411-310-1605) 2 x Socket – Solid (0462-203-04141) 4 x Socket – Solid (0462-209-16141)

HD30/HDP20 Half Kits – Shell Size 18 – 8 Cavities

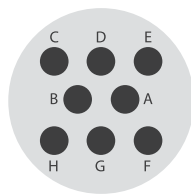

8 x size 12

Connector	Wire Seal	Part No.	Kit Contents
Aluminium Receptacle	Green Ring (Normal)	M34-18-8PN	1 x Receptacle (HD34-18-8PN) 1 x Removal Tool (114010) 9 x Pin – Solid (0460-204-12141) 2 x Cavity Plug (114017) 1 x Panel Nut (114020-90) 1 x Lock Washer (114021)
Aluminium Plug	Green Ring (Normal)	M36-18-8SN	1 x Plug (HD36-18-8SN) 1 x Removal Tool (114010) 9 x Socket – Solid (0462-203-12141) 2 x Cavity Plug (114017)
Aluminium Receptacle	Green Ring (Normal)	M34-18-8SN	1 x Receptacle (HD34-18-8SN) 1 x Removal Tool (114010) 9 x Socket – Solid (0462-203-12141) 2 x Cavity Plug (114017) 1 x Panel Nut (114020-90) 1 x Lock Washer (114021)
Aluminium Plug	Green Ring (Normal)	M36-18-8PN	1 x Plug (HD36-18-8PN) 1 x Removal Tool (114010) 9 x Pin – Solid (0460-204-12141) 2 x Cavity Plug (114017)
Thermoplastic Receptacle	Green Ring (Normal)	P24-18-8PN	1 x Receptacle (HDP24-18-8PN) 1 x Removal Tool (114010) 10 x Pin – Solid (0460-204-12141) 2 x Cavity Plug (114017) 1 x Panel Nut (2411-002-1805) 1 x Lock Washer (2414-002-1886)
Thermoplastic Plug	Green Ring (Normal)	P26-18-8SN	1 x Plug (HDP26-18-8SN) 1 x Removal Tool (114010) 10 x Socket – Solid (0462-203-12141) 2 x Cavity Plug (114017)
Thermoplastic Receptacle	Green Ring (Normal)	P24-18-8SN	1 x Receptacle (HDP24-18-8PN) 1 x Removal Tool (114010) 10 x Socket – Solid (0462-203-12141) 2 x Cavity Plug (114017) 1 x Panel Nut (2411-002-1805) 1 x Lock Washer (2414-002-1886)
Thermoplastic Plug	Green Ring (Normal)	P26-18-8PN	1 x Plug (HDP26-18-8SN) 1 x Removal Tool (114010) 10 x Pin – Solid (0460-204-12141) 2 x Cavity Plug (114017)



HD Series

HD30/HDP20 Half Kits – Shell Size 18 – 14 Cavities

Connector	Wire Seal	Part No.	Kit Contents
Aluminium Receptacle	Green Ring (Normal)	M34-18-14PN	1 x Receptacle (HD34-18-14PN) 1 x Removal Tool (0411-310-1605) 17 x Pin – Solid (0460-215-16141) 6 x Cavity Plug (114017) 1 x Panel Nut (114020-90) 1 x Lock Washer (114021)
Aluminium Plug	Green Ring (Normal)	M36-18-14SN	1 x Plug (HD36-18-14SN) 1 x Removal Tool (0411-310-1605) 17 x Socket – Solid (0462-209-16141) 3 x Cavity Plug (114017)
Aluminium Receptacle	Blue Ring (Extra thin)	M34-18-14SE	1 x Receptacle (HD34-18-14SE) 1 x Removal Tool (0411-204-1605) 17 x Socket – Solid (0462-209-16141) 6 x Cavity Plug (114017) 1 x Panel Nut (114020-90) 1 x Lock Washer (114021)
Aluminium Plug	Blue Ring (Extra thin)	M36-18-14PE	1 x Plug (HD36-18-14PE) 1 x Removal Tool (0411-204-1605) 17 x Pin – Solid (0460-202-16141) 3 x Cavity Plug (114017)
Aluminium Receptacle	Green Ring (Normal)	M34-18-14SN	1 x Receptacle (HD34-18-14SN) 1 x Removal Tool (0411-310-1605) 17 x Socket – Solid (0462-209-16141) 6 x Cavity Plug (114017) 1 x Panel Nut (114020-90) 1 x Lock Washer (114021)
Aluminium Plug	Green Ring (Normal)	M36-18-14PN	1 x Plug (HD36-18-14PN) 1 x Removal Tool (0411-310-1605) 17 x Pin – Solid (0460-215-16141) 3 x Cavity Plug (114017)
Thermoplastic Receptacle	Blue Ring (Extra thin)	P24-18-14PE	1 x Receptacle (HDP24-18-14PE) 1 x Removal Tool (0411-204-1605) 17 x Pin – Solid (0460-202-16141) 6 x Cavity Plug (114017) 1 x Panel Nut (2411-002-1805) 1 x Lock Washer (2414-002-1886)
Thermoplastic Plug	Blue Ring (Extra thin)	P26-18-14SE	1 x Plug (HDP26-18-14SE) 1 x Removal Tool (0411-204-1605) 17 x Socket – Solid (0462-201-16141) 6 x Cavity Plug (114017)
Thermoplastic Receptacle	Green Ring (Normal)	P24-18-14PN	1 x Receptacle (HDP24-18-14PN) 1 x Removal Tool (0411-310-1605) 17 x Pin – Solid (0460-215-16141) 6 x Cavity Plug (114017) 1 x Panel Nut (2411-002-1805) 1 x Lock Washer (2414-002-1886)
Thermoplastic Plug	Green Ring (Normal)	P26-18-14SN	1 x Plug (HDP26-18-14SN) 1 x Removal Tool (0411-310-1605) 17 x Socket – Solid (0462-209-16141) 6 x Cavity Plug (114017)
Thermoplastic Receptacle	Green Ring (Normal)	P24-18-14SN	1 x Receptacle (HDP24-18-14SN) 1 x Removal Tool (0411-310-1605) 17 x Socket – Solid (0462-209-16141) 6 x Cavity Plug (114017) 1 x Panel Nut (2411-002-1805) 1 x Lock Washer (2414-002-1886)
Thermoplastic Plug	Green Ring (Normal)	P26-18-14PN	1 x Plug (HDP26-18-14PN) 1 x Removal Tool (0411-310-1605) 17 x Pin – Solid (0460-215-16141) 6 x Cavity Plug (114017)

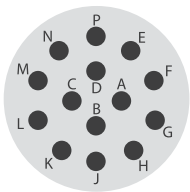

14 x size 16

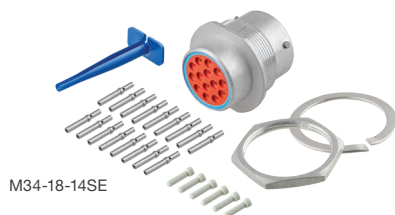

M34-18-14SE



P24-18-14SN

HD30/HDP20 Half Kits – Shell Size 18 – 20 Cavities

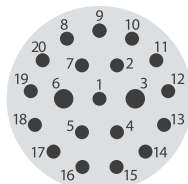

2 x size 16
18 x size 20

Connector	Wire Seal	Part No.	Kit Contents
Aluminium Receptacle	Green Ring (Normal)	M34-18-20SN	1 x Receptacle (HD34-18-20SN) 1 x Removal Tool (0411-310-1605) 1 x Removal Tool (0411-240-2005) 21 x Socket – Solid (0462-201-20141) 3 x Socket – Solid (0462-209-16141) 1 x Cavity Plug (114017) 6 x Cavity Plug (0413-204-2005) 1 x Panel Nut (114020-90) 1 x Lock Washer (114021)
Aluminium Plug	Green Ring (Normal)	M36-18-20PN	1 x Plug (HD36-18-20PN) 1 x Removal Tool (0411-240-2005) 1 x Removal Tool (0411-310-1605) 3 x Pin – Solid (0460-215-16141) 21 x Pin – Solid (0460-202-20141) 1 x Cavity Plug (114017) 6 x Cavity Plug (0413-204-2005)



HD30/HDP20 Half Kits – Shell Size 18 – 21 Cavities

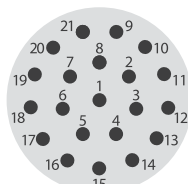

21 x size 20

Connector	Wire Seal	Part No.	Kit Contents
Aluminium Receptacle	Green Ring (Normal)	M34-18-21PN	1 x Receptacle (HD34-18-21PN) 1 x Removal Tool (0411-240-2005) 24 x Pin – Solid (0460-202-20141) 6 x Cavity Plug (114017) 1 x Panel Nut (114020-90) 1 x Lock Washer (114021)
Aluminium Plug	Green Ring (Normal)	M36-18-21SN	1 x Plug (HD36-18-21SN) 1 x Removal Tool (0411-240-2005) 24 x Socket – Solid (0462-201-20141) 6 x Cavity Plug (0413-204-2005)
Aluminium Receptacle	Green Ring (Normal)	M34-18-21SN	1 x Plug (HD36-18-21SN) 1 x Removal Tool (0411-240-2005) 25 x Socket – Solid (0462-201-20141) 6 x Cavity Plug (0413-204-2005) 1 x Panel Nut (114020-90) 1 x Lock Washer (114021)
Aluminium Plug	Green Ring (Normal)	M36-18-21PN	1 x Plug (HD36-18-21PN) 1 x Removal Tool (0411-240-2005) 25 x Pin – Solid (0460-202-20141) 6 x Cavity Plug (0413-204-2005)
Thermoplastic Receptacle	Green Ring (Normal)	P24-18-21PN	1 x Receptacle (HDP24-18-21PN) 1 x Removal Tool (0411-240-2005) 24 x Pin – Solid (0460-202-20141) 6 x Cavity Plug (0413-204-2005) 1 x Panel Nut (2411-002-1805) 1 x Lock Washer (2414-002-1886)
Thermoplastic Plug	Green Ring (Normal)	P26-18-21SN	1 x Plug (HDP26-18-21SN) 1 x Removal Tool (0411-240-2005) 25 x Socket – Solid (0462-201-20141) 6 x Cavity Plug (0413-204-2005)



HD Series

HD30/HDP20 Half Kits – Shell Size 24 – 9 Cavities

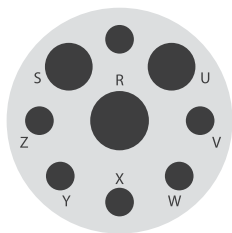

1 x size 4
2 x size 8
6 x size 12

Connector	Wire Seal	Part No.	Kit Contents
Aluminium Receptacle	Green Ring (Normal)	M34-24-9PN	1 x Receptacle (HD34-24-9PN) 1 x Removal Tool (114010) 1 x Removal Tool (114009) 1 x Removal Tool (114008) 7 x Pin – Solid (0460-204-12141) 3 x Pin – Solid (0460-204-08141) 1 x Pin – Solid (0460-204-0490) 1 x Cavity Plug (114019) 1 x Cavity Plug (114018) 3 x Cavity Plug (114017) 1 x Panel Nut (112263-90) 1 x Lock Washer (112264)
Aluminium Plug	Green Ring (Normal)	M36-24-9SN	1 x Plug (HD36-24-9SN) 1 x Removal Tool (114010) 1 x Removal Tool (114009) 1 x Removal Tool (114008) 7 x Socket – Solid (0462-203-12141) 3 x Socket – Solid (0462-203-08141) 1 x Socket – Solid (0462-203-04141) 1 x Cavity Plug (114019) 1 x Cavity Plug (114018) 3 x Cavity Plug (114017)
Aluminium Receptacle	Green Ring (Normal)	M34-24-9SN	1 x Receptacle (HD34-24-9SN) 1 x Removal Tool (114010) 1 x Removal Tool (114009) 1 x Removal Tool (114008) 7 x Socket – Solid (0462-203-12141) 3 x Socket – Solid (0462-203-08141) 1 x Socket – Solid (0462-203-04141) 1 x Cavity Plug (114019) 1 x Cavity Plug (114018) 3 x Cavity Plug (114017) 1 x Panel Nut (112263-90) 1 x Lock Washer (112264)
Aluminium Plug	Green Ring (Normal)	M36-24-9PN	1 x Plug (HD36-24-9PN) 1 x Removal Tool (114010) 1 x Removal Tool (114009) 1 x Removal Tool (114008) 7 x Pin – Solid (0460-204-12141) 3 x Pin – Solid (0460-204-08141) 1 x Pin – Solid (0460-204-0490) 1 x Cavity Plug (114019) 1 x Cavity Plug (114018) 3 x Cavity Plug (114017)
Thermoplastic Receptacle	Green Ring (Normal)	P24-24-9PN	1 x Receptacle (HDP24-24-9PN) 1 x Removal Tool (114008) 1 x Removal Tool (114009) 1 x Removal Tool (114010) 1 x Pin – Solid (0460-204-0490) 2 x Pin – Solid (0460-204-08141) 7 x Pin – Solid (0460-204-12141) 3 x Cavity Plug (114017) 1 x Cavity Plug (114018) 1 x Panel Nut (2411-001-2405) 1 x Lock Washer (2414-001-2486)
Thermoplastic Plug	Green Ring (Normal)	P26-24-9SN	1 x Plug (HDP26-24-9SN) 1 x Removal Tool (114008) 1 x Removal Tool (114009) 1 x Removal Tool (114010) 7 x Socket – Solid (0462-203-12141) 1 x Socket – Solid (0462-203-04141) 2 x Socket – Solid (0462-203-08141) 2 x Cavity Plug (114017) 1 x Cavity Plug (114018)
Thermoplastic Receptacle	Green Ring (Normal)	P24-24-9SN	1 x Receptacle (HDP24-24-9SN) 1 x Removal Tool (114008) 1 x Removal Tool (114009) 1 x Removal Tool (114010) 7 x Socket – Solid (0462-203-12141) 1 x Socket – Solid (0462-203-04141) 2 x Socket – Solid (0462-203-08141) 3 x Cavity Plug (114017) 1 x Cavity Plug (114018) 1 x Panel Nut (2411-001-2405) 1 x Lock Washer (2414-001-2486)
Thermoplastic Plug	Green Ring (Normal)	P26-24-9PN	1 x Plug (HDP26-24-9PN) 1 x Removal Tool (114008) 1 x Removal Tool (114009) 1 x Removal Tool (114010) 1 x Pin – Solid (0460-204-0490) 2 x Pin – Solid (0460-204-08141) 7 x Pin – Solid (0460-204-12141) 3 x Cavity Plug (114017) 1 x Cavity Plug (114018)

HD30/HDP20 Half Kits – Shell Size 24 – 14 Cavities

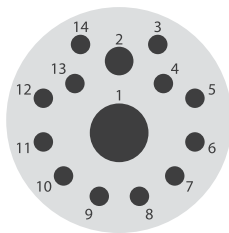

1 x size 4
1 x size 12
12 x size 16

Connector	Wire Seal	Part No.	Kit Contents
Aluminium Receptacle	Green Ring (Normal)	M34-24-14PN	1 x Receptacle (HD34-24-14PN) 1 x Removal Tool (114010) 1 x Removal Tool (114009) 1 x Removal Tool (0411-310-1605) 15 x Pin – Solid (0460-215-16141) 2 x Pin – Solid (0460-204-12141) 1 x Pin – Solid (0460-204-0490) 5 x Cavity Plug (114017) 1 x Panel Nut (112263-90) 1 x Lock Washer (112264)
Aluminium Plug	Green Ring (Normal)	M36-24-14SN	1 x Plug (HD36-24-14SN) 1 x Removal Tool (114010) 1 x Removal Tool (114009) 1 x Removal Tool (0411-310-1605) 15 x Socket – Solid (0462-209-16141) 2 x Socket – Solid (0462-203-12141) 2 x Socket – Solid (0462-203-04141) 5 x Cavity Plug (114017)
Aluminium Receptacle	Green Ring (Normal)	M34-24-14SN	1 x Receptacle (HD34-24-14SN) 1 x Removal Tool (0411-310-1605) 1 x Removal Tool (114010) 1 x Removal Tool (114009) 1 x Socket – Solid (0462-203-04141) 2 x Socket – Solid (0462-203-12141) 15 x Socket – Solid (0462-209-16141) 5 x Cavity Plug (114017) 1 x Panel Nut (112263-90) 1 x Lock Washer (112264)
Aluminium Plug	Green Ring (Normal)	M36-24-14PN	1 x Plug (HD36-24-14PN) 1 x Removal Tool (114010) 1 x Removal Tool (114009) 1 x Removal Tool (0411-310-1605) 15 x Pin – Solid (0460-215-16141) 2 x Pin – Solid (0460-204-12141) 1 x Pin – Solid (0460-204-0490) 5 x Cavity Plug (114017)

HD30/HDP20 Half Kits – Shell Size 24 – 16 Cavities

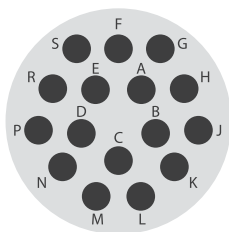

16 x size 12

Connector	Wire Seal	Part No.	Kit Contents
Aluminium Receptacle	Green Ring (Normal)	M34-24-16PN	1 x Receptacle (HD34-24-16PN) 1 x Removal Tool (114010) 19 x Pin – Solid (0460-204-12141) 5 x Cavity Plug (114017) 1 x Panel Nut (112263-90) 1 x Lock Washer (112264)
Aluminium Plug	Green Ring (Normal)	M36-24-16SN	1 x Plug (HD36-24-16SN) 1 x Removal Tool (114010) 19 x Socket – Solid (0462-203-12141) 5 x Cavity Plug (114017)
Aluminium Plug	Green Ring (Normal)	M36-24-16PN	1 x Plug (HD36-24-16PN) 1 x Removal Tool (114010) 19 x Pin – Solid (0460-204-12141) 5 x Cavity Plug (114017)
Thermoplastic Receptacle	Green Ring (Normal)	P24-24-16PN	1 x Receptacle (HDP24-24-16PN) 1 x Removal Tool (114010) 19 x Pin – Solid (0460-204-12141) 5 x Cavity Plug (114017) 1 x Panel Nut (2411-001-2405) 1 x Lock Washer (2414-001-2486)
Thermoplastic Plug	Green Ring (Normal)	P26-24-16SN	1 x Plug (HDP26-24-16SN) 1 x Removal Tool (114010) 19 x Socket – Solid (0462-203-12141) 5 x Cavity Plug (114017)



HD Series

HD30/HDP20 Half Kits – Shell Size 24 – 18 Cavities

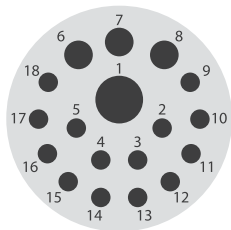

1 x size 8
3 x size 12
14 x size 16

Connector	Wire Seal	Part No.	Kit Contents
Aluminium Receptacle	Green Ring (Normal)	M34-24-18PN	1 x Receptacle (HD34-24-18PN) 1 x Removal Tool (0411-310-1605) 1 x Removal Tool (114008) 1 x Removal Tool (114010) 2 x Pin – Solid (0460-204-08141) 4 x Pin – Solid (0460-204-12141) 17 x Pin – Solid (0460-215-16141) 6 x Cavity Plug (114017) 1 x Panel Nut (112263-90) 1 x Lock Washer (112264)
Aluminium Plug	Green Ring (Normal)	M36-24-18SN	1 x Plug (HD36-24-18SN) 1 x Removal Tool (0411-310-1605) 1 x Removal Tool (114008) 1 x Removal Tool (114010) 2 x Socket – Solid (0462-203-08141) 4 x Socket – Solid (0462-203-12141) 17 x Socket – Solid (0462-209-16141) 6 x Cavity Plug (114017)
Aluminium Receptacle	Blue Ring (Extra thin)	M34-24-18SE	1 x Receptacle (HD34-24-18SE) 1 x Removal Tool (0411-337-1205) 1 x Removal Tool (114008) 1 x Removal Tool (0411-204-1605) 2 x Socket – Solid (0462-203-08141) 4 x Socket – Solid (0462-203-12141) 16 x Socket – Solid (0462-201-16141) 6 x Cavity Plug (114017) 1 x Panel Nut (112263-90) 1 x Lock Washer (112264)
Aluminium Plug	Blue Ring (Extra thin)	M36-24-18PE	1 x Plug (HD36-24-18PE) 1 x Removal Tool (0411-337-1205) 1 x Removal Tool (114008) 1 x Removal Tool (0411-204-1605) 2 x Pin – Solid (0460-204-08141) 4 x Pin – Solid (0460-204-12141) 17 x Pin – Solid (0460-202-16141) 6 x Cavity Plug (114017)
Thermoplastic Receptacle	Green Ring (Normal)	P24-24-18PN	1 x Receptacle (HDP24-24-18PN) 1 x Removal Tool (0411-310-1605) 1 x Removal Tool (114008) 1 x Removal Tool (114010) 2 x Pin – Solid (0460-204-08141) 4 x Pin – Solid (0460-204-12141) 17 x Pin – Solid (0460-215-16141) 6 x Cavity Plug (114017) 1 x Panel Nut (2411-001-2405) 1 x Lock Washer (2414-001-2486)
Thermoplastic Plug	Green Ring (Normal)	P26-24-18SN	1 x Plug (HDP26-24-18SN) 1 x Removal Tool (0411-310-1605) 1 x Removal Tool (114008) 1 x Removal Tool (114010) 2 x Socket – Solid (0462-203-08141) 4 x Socket – Solid (0462-203-12141) 17 x Socket – Solid (0462-209-16141) 6 x Cavity Plug (114017)
Thermoplastic Receptacle	Green Ring (Normal)	P24-24-18SN	1 x Receptacle (HDP24-24-18SN) 1 x Removal Tool (0411-310-1605) 1 x Removal Tool (114008) 1 x Removal Tool (114010) 2 x Socket – Solid (0462-203-08141) 4 x Socket – Solid (0462-203-12141) 17 x Socket – Solid (0462-209-16141) 6 x Cavity Plug (114017) 1 x Panel Nut (2411-001-2405) 1 x Lock Washer (2414-001-2486)
Thermoplastic Plug	Green Ring (Normal)	P26-24-18PN	1 x Plug (HDP26-24-18PN) 1 x Removal Tool (0411-310-1605) 1 x Removal Tool (114008) 1 x Removal Tool (114010) 2 x Pin – Solid (0460-204-08141) 4 x Pin – Solid (0460-204-12141) 17 x Pin – Solid (0460-215-16141) 6 x Cavity Plug (114017)

HD30/HDP20 Half Kits – Shell Size 24 – 19 Cavities

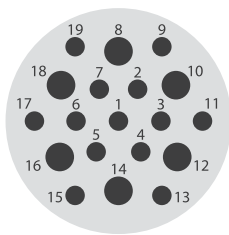

6 x size 12
13 x size 16

Connector	Wire Seal	Part No.	Kit Contents
Aluminium Receptacle	Blue Ring (Extra thin)	M34-24-19PE	<ul style="list-style-type: none"> 1 x Receptacle (HD34-24-19PE) 1 x Removal Tool (0411-204-1605) 1 x Removal Tool (0411-337-1205) 7 x Pin – Solid (0460-204-12141) 16 x Pin – Solid (0460-202-16141) 6 x Cavity Plug (114017) 1 x Panel Nut (112263-90) 1 x Lock Washer (112264)
Aluminium Plug	Blue Ring (Extra thin)	M36-24-19SE	<ul style="list-style-type: none"> 1 x Plug (HD36-24-19SE) 1 x Removal Tool (0411-204-1605) 1 x Removal Tool (0411-337-1205) 7 x Socket – Solid (0462-203-12141) 16 x Socket – Solid (0462-202-16141) 6 x Cavity Plug (114017)
Aluminium Receptacle	Green Ring (Normal)	M34-24-19PN	<ul style="list-style-type: none"> 1 x Receptacle (HD34-24-19PN) 1 x Removal Tool (0411-204-1605) 1 x Removal Tool (114010) 7 x Pin – Solid (0460-204-12141) 16 x Pin – Solid (0460-215-16141) 6 x Cavity Plug (114017) 1 x Panel Nut (112263-90) 1 x Lock Washer (112264)
Aluminium Receptacle	Blue Ring (Extra thin)	M34-24-19SE	<ul style="list-style-type: none"> 1 x Receptacle (HD34-24-19SE) 1 x Removal Tool (0411-204-1605) 1 x Removal Tool (0411-337-1205) 7 x Socket – Solid (0462-203-12141) 16 x Socket – Solid (0462-201-16141) 6 x Cavity Plug (114017) 1 x Panel Nut (112263-90) 1 x Lock Washer (112264)
Aluminium Plug	Blue Ring (Extra thin)	M36-24-19PE	<ul style="list-style-type: none"> 1 x Plug (HD36-24-19PE) 1 x Removal Tool (0411-204-1605) 1 x Removal Tool (0411-337-1205) 7 x Pin – Solid (0460-204-12141) 16 x Pin – Solid (0460-202-16141) 6 x Cavity Plug (114017)
Thermoplastic Receptacle	Blue Ring (Extra thin)	P24-24-19PE	<ul style="list-style-type: none"> 1 x Receptacle (HDP24-24-19PE) 1 x Removal Tool (0411-204-1605) 1 x Removal Tool (114010) 7 x Pin – Solid (0460-204-12141) 16 x Pin – Solid (0460-202-16141) 6 x Cavity Plug (114017) 1 x Panel Nut (2411-001-2405) 1 x Lock Washer (2414-001-2486)
Thermoplastic Receptacle	Green Ring (Normal)	P24-24-19PN	<ul style="list-style-type: none"> 1 x Receptacle (HDP24-24-19PN) 1 x Removal Tool (0411-310-1605) 1 x Removal Tool (114010) 7 x Pin – Solid (0460-204-12141) 16 x Pin – Solid (0460-215-16141) 6 x Cavity Plug (114017) 1 x Panel Nut (2411-001-2405) 1 x Lock Washer (2414-001-2486)
Thermoplastic Plug	Green Ring (Normal)	P26-24-19SN	<ul style="list-style-type: none"> 1 x Plug (HDP26-24-19SN) 1 x Removal Tool (0411-310-1605) 1 x Removal Tool (114010) 7 x Socket – Solid (0462-203-12141) 16 x Socket – Solid (0462-209-16141) 6 x Cavity Plug (114017)



M34-24-19PE



HD Series

HD30/HDP20 Half Kits – Shell Size 24 – 21 Cavities

Connector	Wire Seal	Part No.	Kit Contents
Aluminium Receptacle	Blue Ring (Extra thin)	M34-24-21PE	1 x Receptacle (HD34-24-21PE) 1 x Removal Tool (0411-204-1605) 1 x Removal Tool (0411-337-1205) 5 x Pin – Solid (0460-204-12141) 20 x Pin – Solid (0460-202-16141) 6 x Cavity Plug (114017) 1 x Panel Nut (112263-90) 1 x Lock Washer (112264)
Aluminium Plug	Blue Ring (Extra thin)	M36-24-21SE	1 x Plug (HD36-24-21SE) 1 x Removal Tool (0411-204-1605) 1 x Removal Tool (0411-337-1205) 5 x Socket – Solid (0462-203-12141) 20 x Socket – Solid (0462-201-16141) 6 x Cavity Plug (114017)
Aluminium Receptacle	Green Ring (Normal)	M34-24-21PN	1 x Receptacle (HD34-24-21PN) 1 x Removal Tool (114010) 1 x Removal Tool (0411-310-1605) 20 x Pin – Solid (0460-215-16141) 5 x Pin – Solid (0460-204-12141) 6 x Cavity Plug (114017) 1 x Panel Nut (112263-90) 1 x Lock Washer (112264)
Aluminium Plug	Green Ring (Normal)	M36-24-21SN	1 x Plug (HD36-24-21SN) 1 x Removal Tool (114010) 1 x Removal Tool (0411-310-1605) 20 x Socket – Solid (0462-209-16141) 5 x Socket – Solid (0462-203-12141) 6 x Cavity Plug (114017)
Aluminium Receptacle	Green Ring (Normal)	M34-24-21SN	1 x Receptacle (HD34-24-21SN) 1 x Removal Tool (114010) 1 x Removal Tool (0411-310-1605) 20 x Socket – Solid (0462-209-16141) 5 x Socket – Solid (0462-203-12141) 6 x Cavity Plug (114017) 1 x Panel Nut (112263-90) 1 x Lock Washer (112264)
Aluminium Plug	Green Ring (Normal)	M36-24-21PN	1 x Plug (HD36-24-21PN) 1 x Removal Tool (114010) 1 x Removal Tool (0411-310-1605) 20 x Pin – Solid (0460-215-16141) 5 x Pin – Solid (0460-204-12141) 6 x Cavity Plug (114017)
Thermoplastic Receptacle	Blue Ring (Extra thin)	P24-24-21PE	1 x Receptacle (HDP24-24-21PE) 1 x Removal Tool (0411-204-1605) 1 x Removal Tool (0411-337-1205) 5 x Pin – Solid (0460-204-12141) 20 x Pin – Solid (0460-202-16141) 6 x Cavity Plug (114017) 1 x Panel Nut (2411-001-2405) 1 x Lock Washer (2414-001-2486)
Thermoplastic Plug	Blue Ring (Extra thin)	P26-24-21SE	1 x Plug (HDP26-24-21SE) 1 x Removal Tool (0411-204-1605) 1 x Removal Tool (0411-337-1205) 5 x Socket – Solid (0462-203-12141) 20 x Socket – Solid (0462-201-16141) 6 x Cavity Plug (114017)
Thermoplastic Receptacle	Green Ring (Normal)	P24-24-21PN	1 x Receptacle (HDP24-24-21PN) 1 x Removal Tool (0411-310-1605) 1 x Removal Tool (114010) 5 x Pin – Solid (0460-204-12141) 20 x Pin – Solid (0460-215-16141) 6 x Cavity Plug (114017) 1 x Panel Nut (2411-001-2405) 1 x Lock Washer (2414-001-2486)
Thermoplastic Plug	Green Ring (Normal)	P26-24-21SN	1 x Plug (HDP26-24-21SN) 1 x Removal Tool (0411-310-1605) 1 x Removal Tool (114010) 5 x Socket – Solid (0462-203-12141) 20 x Socket – Solid (0462-209-16141) 6 x Cavity Plug (114017)

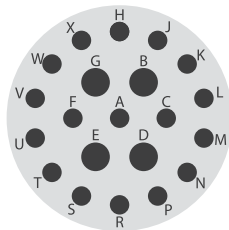

4 x size 12
17 x size 16

HD30/HDP20 Half Kits – Shell Size 24 – 23 Cavities

Connector	Wire Seal	Part No.	Kit Contents
Aluminium Receptacle	Blue Ring (Extra thin)	M34-24-23PE	1 x Receptacle (HD34-24-23PE) 1 x Removal Tool (0411-204-1605) 26 x Pin – Solid (0460-202-16141) 8 x Cavity Plug (114017) 1 x Panel Nut (112263-90) 1 x Lock Washer (112264)
Aluminium Plug	Blue Ring (Extra thin)	M36-24-23SE	1 x Plug (HD36-24-23SE) 1 x Removal Tool (0411-204-1605) 26 x Socket – Solid (0462-201-16141) 8 x Cavity Plug (114017)
Aluminium Receptacle	Blue Ring (Extra thin)	M34-24-23SE	1 x Receptacle (HD34-24-23SE) 1 x Removal Tool (0411-204-1605) 26 x Socket – Solid (0462-201-16141) 8 x Cavity Plug (114017) 1 x Panel Nut (112263-90) 1 x Lock Washer (112264)
Aluminium Plug	Blue Ring (Extra thin)	M36-24-23PE	1 x Plug (HD36-24-23PE) 1 x Removal Tool (0411-204-1605) 26 x Pin – Solid (0460-202-16141) 8 x Cavity Plug (114017)
Aluminium Receptacle	Green Ring (Normal)	M34-24-23PN	1 x Receptacle (HD34-24-23PN) 1 x Removal Tool (0411-310-1605) 26 x Pin – Solid (0460-215-16141) 8 x Cavity Plug (114017) 1 x Panel Nut (112263-90) 1 x Lock Washer (112264)
Aluminium Plug	Green Ring (Normal)	M36-24-23SN	1 x Plug (HD36-24-23SN) 1 x Removal Tool (0411-310-1605) 26 x Socket – Solid (0462-209-16141) 8 x Cavity Plug (114017)
Aluminium Receptacle	Green Ring (Normal)	M34-24-23SN	1 x Receptacle (HD34-24-23SN) 1 x Removal Tool (0411-310-1605) 26 x Socket – Solid (0462-209-16141) 8 x Cavity Plug (114017) 1 x Panel Nut (112263-90) 1 x Lock Washer (112264)
Aluminium Plug	Green Ring (Normal)	M36-24-23PN	1 x Plug (HD36-24-23PN) 1 x Removal Tool (0411-310-1605) 26 x Pin – Solid (0460-215-16141) 8 x Cavity Plug (114017)
Aluminium Receptacle	Grey Ring (Thin)	M34-24-23PT	1 x Receptacle (HD34-24-23PT) 1 x Removal Tool (0411-310-1605) 26 x Pin – Solid (0460-215-16141) 8 x Cavity Plug (114017) 1 x Panel Nut (112263-90) 1 x Lock Washer (112264)
Aluminium Receptacle	Grey Ring (Thin)	M34-24-23ST	1 x Receptacle (HD34-24-23ST) 1 x Removal Tool (0411-310-1605) 26 x Socket – Solid (0462-209-16141) 8 x Cavity Plug (114017) 1 x Panel Nut (112263-90) 1 x Lock Washer (112264)

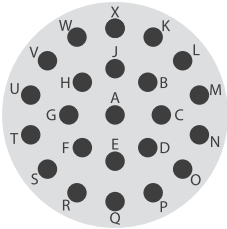

23 x size 16

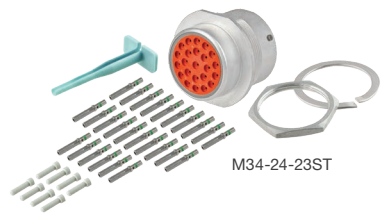

HD Series

HD30/HDP20 Half Kits – Shell Size 24 – 23 Cavities cont.

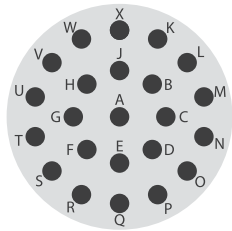

23 x size 16

Connector	Wire Seal	Part No.	Kit Contents
Thermoplastic Receptacle	Green Ring (Normal)	P24-24-23PN	1 x Receptacle (HDP24-24-23PN) 1 x Removal Tool (0411-310-1605) 26 x Pin – Solid (0460-215-16141) 8 x Cavity Plug (114017) 1 x Panel Nut (2411-001-2405) 1 x Lock Washer (2414-001-2486)
Thermoplastic Plug	Green Ring (Normal)	P26-24-23SN	1 x Plug (HDP26-24-23SN) 1 x Removal Tool (0411-310-1605) 26 x Socket – Solid (0462-209-16141) 8 x Cavity Plug (114017)
Thermoplastic Receptacle	Blue Ring (Extra thin)	P24-24-23SE	1 x Receptacle (HDP24-24-23SE) 1 x Removal Tool (0411-204-1605) 26 x Socket – Solid (0462-201-16141) 8 x Cavity Plug (114017) 1 x Panel Nut (2411-001-2405) 1 x Lock Washer (2414-001-2486)
Thermoplastic Plug	Blue Ring (Extra thin)	P26-24-23PE	1 x Plug (HDP26-24-23PE) 1 x Removal Tool (0411-204-1605) 26 x Pin – Solid (0460-202-16141) 8 x Cavity Plug (114017)
Thermoplastic Receptacle	Green Ring (Normal)	P24-24-23SN	1 x Receptacle (HDP24-24-23SN) 1 x Removal Tool (0411-310-1605) 26 x Socket – Solid (0462-209-16141) 8 x Cavity Plug (114017) 1 x Panel Nut (2411-001-2405) 1 x Lock Washer (2414-001-2486)
Thermoplastic Plug	Green Ring (Normal)	P26-24-23PN	1 x Plug (HDP26-24-23PN) 1 x Removal Tool (0411-310-1605) 26 x Pin – Solid (0460-215-16141) 8 x Cavity Plug (114017)

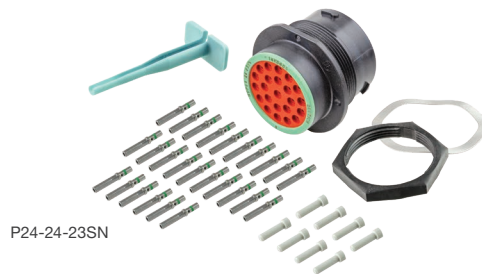

P24-24-23SN

HD30/HDP20 Half Kits – Shell Size 24 – 29 Cavities

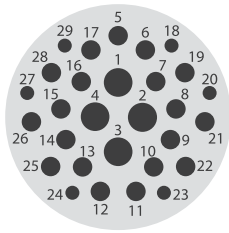

4 x size 12
19 x size 16
6 x size 20

Connector	Wire Seal	Part No.	Kit Contents
Aluminium Receptacle	Blue Ring (Extra thin)	M34-24-29PE	1 x Receptacle (HD34-24-29PE) 1 x Removal Tool (0411-240-2005) 1 x Removal Tool (0411-204-1605) 1 x Removal Tool (0411-337-1205) 22 x Pin – Solid (0460-202-16141) 5 x Pin – Solid (0460-204-12141) 7 x Pin – Solid (0460-202-20141) 2 x Cavity Plug (0413-204-2005) 8 x Cavity Plug (114017) 1 x Panel Nut (112263-90) 1 x Lock Washer (112264)
Aluminium Plug	Blue Ring (Extra thin)	M36-24-29SE	1 x Plug (HD36-24-29SE) 1 x Removal Tool (0411-337-1205) 1 x Removal Tool (0411-240-2005) 1 x Removal Tool (0411-204-1605) 22 x Socket – Solid (0462-201-16141) 5 x Socket – Solid (0462-203-12141) 7 x Socket – Solid (0462-201-20141) 2 x Cavity Plug (0413-204-2005) 8 x Cavity Plug (114017)
Aluminium Receptacle	Blue Ring (Extra thin)	M34-24-29SE	1 x Receptacle (HD34-24-29SE) 1 x Removal Tool (0411-240-2005) 1 x Removal Tool (0411-204-1605) 1 x Removal Tool (0411-337-1205) 22 x Socket – Solid (0462-201-16141) 5 x Socket – Solid (0462-203-12141) 7 x Socket – Solid (0462-201-20141) 2 x Cavity Plug (0413-204-2005) 8 x Cavity Plug (114017) 1 x Panel Nut (112263-90) 1 x Lock Washer (112264)
Aluminium Plug	Blue Ring (Extra thin)	M36-24-29PE	1 x Plug (HD36-24-29PE) 1 x Removal Tool (0411-240-2005) 1 x Removal Tool (0411-204-1605) 1 x Removal Tool (0411-337-1205) 22 x Pin – Solid (0460-202-16141) 5 x Pin – Solid (0460-204-12141) 7 x Pin – Solid (0460-202-20141) 2 x Cavity Plug (0413-204-2005) 8 x Cavity Plug (114017)
Thermoplastic Receptacle	Blue Ring (Extra thin)	P24-24-29PE	1 x Receptacle (HDP24-24-29PE) 1 x Removal Tool (0411-240-2005) 1 x Removal Tool (0411-204-1605) 1 x Removal Tool (0411-337-1205) 22 x Pin – Solid (0460-202-16141) 5 x Pin – Solid (0460-204-12141) 7 x Pin – Solid (0460-202-20141) 2 x Cavity Plug (0413-204-2005) 8 x Cavity Plug (114017) 1 x Panel Nut (2411-001-2405) 1 x Lock Washer (2414-001-2486)
Thermoplastic Plug	Blue Ring (Extra thin)	P26-24-29SE	1 x Plug (HDP26-24-29SE) 1 x Removal Tool (0411-240-2005) 1 x Removal Tool (0411-204-1605) 1 x Removal Tool (0411-337-1205) 22 x Socket – Solid (0462-201-16141) 5 x Socket – Solid (0462-203-12141) 7 x Socket – Solid (0462-201-20141) 2 x Cavity Plug (0413-204-2005) 8 x Cavity Plug (114017)
Thermoplastic Receptacle	Blue Ring (Extra thin)	P24-24-29SE	1 x Receptacle (HDP24-24-29SE) 1 x Removal Tool (0411-240-2005) 1 x Removal Tool (0411-204-1605) 1 x Removal Tool (0411-337-1205) 22 x Socket – Solid (0462-201-16141) 5 x Socket – Solid (0462-203-12141) 7 x Socket – Solid (0462-201-20141) 2 x Cavity Plug (0413-204-2005) 8 x Cavity Plug (114017) 1 x Panel Nut (2411-001-2405) 1 x Lock Washer (2414-001-2486)
Thermoplastic Plug	Blue Ring (Extra thin)	P26-24-29PE	1 x Plug (HDP26-24-29PE) 1 x Removal Tool (0411-240-2005) 1 x Removal Tool (0411-204-1605) 1 x Removal Tool (0411-337-1205) 22 x Pin – Solid (0460-202-16141) 5 x Pin – Solid (0460-204-12141) 7 x Pin – Solid (0460-202-20141) 2 x Cavity Plug (0413-204-2005) 8 x Cavity Plug (114017)



HD Series

HD30/HDP20 Half Kits – Shell Size 24 – 31 Cavities

Connector	Wire Seal	Part No.	Kit Contents
Aluminium Receptacle	Blue Ring (Extra thin)	M34-24-31PE	1 x Receptacle (HD34-24-31PE) 1 x Removal Tool (0411-204-1605) 36 x Pin – Solid (0460-202-16141) 10 x Cavity Plug (114017) 1 x Panel Nut (112263-90) 1 x Lock Washer (112264)
Aluminium Plug	Blue Ring (Extra thin)	M36-24-31SE	1 x Plug (HD36-24-31SE) 1 x Removal Tool (0411-204-1605) 36 x Socket – Solid (0462-201-16141) 10 x Cavity Plug (114017)
Aluminium Receptacle	Grey Ring (Thin)	M34-24-31PT	1 x Receptacle (HD34-24-31PT) 1 x Removal Tool (0411-310-1605) 36 x Pin – Solid (0460-215-16141) 10 x Cavity Plug (114017) 1 x Panel Nut (112263-90) 1 x Lock Washer (112264)
Aluminium Plug	Grey Ring (Thin)	M36-24-31ST	1 x Plug (HD36-24-31ST) 1 x Removal Tool (0411-310-1605) 36 x Socket – Solid (0462-209-16141) 10 x Cavity Plug (114017)
Aluminium Receptacle	Grey Ring (Thin)	M34-24-31ST	1 x Receptacle (HD34-24-31ST) 1 x Removal Tool (0411-310-1605) 36 x Socket – Solid (0462-209-16141) 10 x Cavity Plug (114017) 1 x Panel Nut (112263-90) 1 x Lock Washer (112264)
Aluminium Plug	Grey Ring (Thin)	M36-24-31PT	1 x Plug (HD36-24-31PT) 1 x Removal Tool (0411-310-1605) 36 x Pin – Solid (0460-215-16141) 10 x Cavity Plug (114017)
Thermoplastic Receptacle	Blue Ring (Extra thin)	P24-24-31PE	1 x Receptacle (HDP24-24-31PE) 1 x Removal Tool (0411-204-1605) 36 x Pin – Solid (0460-202-16141) 10 x Cavity Plug (114017) 1 x Panel Nut (2411-001-2405) 1 x Lock Washer (2414-001-2486)
Thermoplastic Plug	Blue Ring (Extra thin)	P26-24-31SE	1 x Plug (HDP26-24-31SE) 1 x Removal Tool (0411-204-1605) 36 x Socket – Solid (0462-201-16141) 10 x Cavity Plug (114017)
Thermoplastic Receptacle	Grey Ring (Thin)	P24-24-31PT	1 x Receptacle (HDP24-24-31PT) 1 x Removal Tool (0411-310-1605) 36 x Pin – Solid (0460-215-16141) 10 x Cavity Plug (114017) 1 x Panel Nut (2411-001-2405) 1 x Lock Washer (2414-001-2486)
Thermoplastic Plug	Grey Ring (Thin)	P26-24-31ST	1 x Plug (HDP26-24-31ST) 1 x Removal Tool (0411-310-1605) 36 x Socket – Solid (0462-209-16141) 10 x Cavity Plug (114017)
Thermoplastic Receptacle	Blue Ring (Extra thin)	P24-24-31SE	1 x Receptacle (HDP24-24-31SE) 1 x Removal Tool (0411-204-1605) 36 x Socket – Solid (0462-201-16141) 10 x Cavity Plug (114017) 1 x Panel Nut (2411-001-2405) 1 x Lock Washer (2414-001-2486)
Thermoplastic Plug	Blue Ring (Extra thin)	P26-24-31PE	1 x Plug (HDP26-24-31PE) 1 x Removal Tool (0411-204-1605) 36 x Pin – Solid (0460-202-16141) 10 x Cavity Plug (114017)
Thermoplastic Receptacle	Grey Ring (Thin)	P24-24-31ST	1 x Receptacle (HDP24-24-31ST) 1 x Removal Tool (0411-310-1605) 36 x Socket – Solid (0462-209-16141) 10 x Cavity Plug (114017) 1 x Panel Nut (2411-001-2405) 1 x Lock Washer (2414-001-2486)
Thermoplastic Plug	Grey Ring (Thin)	P26-24-31PT	1 x Plug (HDP26-24-31PT) 1 x Removal Tool (0411-310-1605) 36 x Pin – Solid (0460-215-16141) 10 x Cavity Plug (114017)

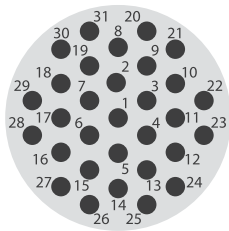

31 x size 16

HD30/HDP20 Half Kits – Shell Size 24 – 33 Cavities

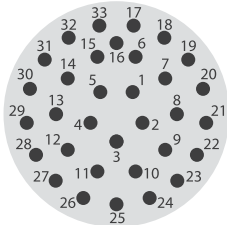

33 x size 20

Connector	Wire Seal	Part No.	Kit Contents
Aluminium Receptacle	Green Ring (Normal)	M34-24-33SN	1 x Receptacle (HD34-24-33SN) 1 x Removal Tool (0411-240-2005) 36 x Socket – Solid (0462-201-20141) 10 x Cavity Plug (0413-204-2005) 1 x Panel Nut (112263-90) 1 x Lock Washer (112264)
Aluminium Plug	Green Ring (Normal)	M36-24-33PN	1 x Plug (HD36-24-33PN) 1 x Removal Tool (0411-240-2005) 36 x Pin – Solid (0460-202-20141) 10 x Cavity Plug (0413-204-2005)



M34-24-35PN

HD30/HDP20 Half Kits – Shell Size 24 – 35 Cavities

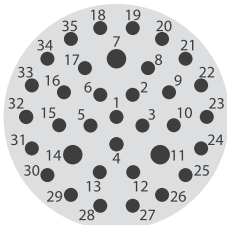

3 x size 16
32 x size 20

Connector	Wire Seal	Part No.	Kit Contents
Aluminium Receptacle	Green Ring (Normal)	M34-24-35PN	1 x Receptacle (HD34-24-35PN) 1 x Removal Tool (0411-240-2005) 1 x Removal Tool (0411-310-1605) 36 x Pin – Solid (0460-202-20141) 4 x Pin – Solid (0460-215-16141) 2 x Cavity Plug (114017) 10 x Cavity Plug (0413-204-2005) 1 x Panel Nut (112263-90) 1 x Lock Washer (112264)
Aluminium Plug	Green Ring (Normal)	M36-24-35PN	1 x Plug (HD36-24-35PN) 1 x Removal Tool (0411-240-2005) 1 x Removal Tool (0411-310-1605) 36 x Socket – Solid (0462-201-20141) 4 x Socket – Solid (0462-209-16141) 10 x Cavity Plug (0413-204-2005) 2 x Cavity Plug (114017)
Aluminium Receptacle	Green Ring (Normal)	M34-24-35SN	1 x Receptacle (HD34-24-35SN) 1 x Removal Tool (0411-240-2005) 1 x Removal Tool (0411-310-1605) 36 x Socket – Solid (0462-201-20141) 4 x Socket – Solid (0462-209-16141) 2 x Cavity Plug (114017) 10 x Cavity Plug (0413-204-2005) 1 x Panel Nut (112263-90) 1 x Lock Washer (112264)
Aluminium Plug	Green Ring (Normal)	M36-24-35PN	1 x Plug (HD36-24-35PN) 1 x Removal Tool (0411-240-2005) 1 x Removal Tool (0411-310-1605) 36 x Pin – Solid (0460-202-20141) 4 x Pin – Solid (0460-215-16141) 2 x Cavity Plug (114017) 10 x Cavity Plug (0413-204-2005)



HD Series

HD30/HDP20 Half Kits – Shell Size 24 – 47 Cavities

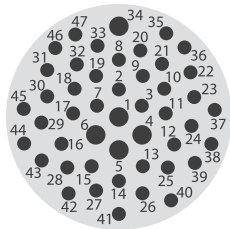

5 x size 16
42 x size 20

Connector	Wire Seal	Part No.	Kit Contents
Aluminium Receptacle	Blue Ring (Extra thin)	M34-24-47PE	1 x Receptacle (HD34-24-47PE) 1 x Removal Tool (0411-204-1605) 1 x Removal Tool (0411-240-2005) 47 x Pin – Solid (0460-202-20141) 6 x Pin – Solid (0460-202-16141) 2 x Cavity Plug (114017) 10 x Cavity Plug (0413-204-2005) 1 x Panel Nut (112263-90) 1 x Lock Washer (112264)
Aluminium Plug	Blue Ring (Extra thin)	M36-24-47SE	1 x Plug (HD36-24-47SE) 1 x Removal Tool (0411-240-2005) 1 x Removal Tool (0411-204-1605) 6 x Socket – Solid (0462-201-20141) 47 x Socket – Solid (0462-201-20141) 10 x Cavity Plug (0413-204-2005) 2 x Cavity Plug (114017)
Aluminium Receptacle	Blue Ring (Extra thin)	M34-24-47SE	1 x Receptacle (HD34-24-47SE) 1 x Removal Tool (0411-204-1605) 1 x Removal Tool (0411-240-2005) 47 x Socket – Solid (0462-201-20141) 6 x Socket – Solid (0462-201-16141) 2 x Cavity Plug (114017) 10 x Cavity Plug (0413-204-2005) 1 x Panel Nut (112263-90) 1 x Lock Washer (112264)
Aluminium Plug	Blue Ring (Extra thin)	M36-24-47PE	1 x Plug (HD36-24-47PE) 1 x Removal Tool (0411-204-1605) 1 x Removal Tool (0411-240-2005) 47 x Pin – Solid (0460-202-20141) 6 x Pin – Solid (0460-202-16141) 2 x Cavity Plug (114017) 10 x Cavity Plug (0413-204-2005)
Thermoplastic Receptacle	Blue Ring (Extra thin)	P24-24-47SE	1 x Receptacle (HDP24-24-47SE) 1 x Removal Tool (0411-204-1605) 1 x Removal Tool (0411-240-2005) 47 x Socket – Solid (0462-201-20141) 6 x Socket – Solid (0462-201-16141) 2 x Cavity Plug (114017) 10 x Cavity Plug (0413-204-2005) 1 x Panel Nut (2411-001-2405) 1 x Lock Washer (2414-001-2486)
Thermoplastic Plug	Blue Ring (Extra thin)	P26-24-47PE	1 x Plug (HDP26-24-47PE) 1 x Removal Tool (0411-204-1605) 1 x Removal Tool (0411-240-2005) 47 x Pin – Solid (0460-202-20141) 6 x Pin – Solid (0460-202-16141) 2 x Cavity Plug (114017) 10 x Cavity Plug (0413-204-2005)

HD30/HDP20 Half Kits – Shell Size 24 – 91

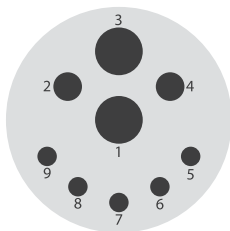

2 x size 8
2 x size 12
5 x size 16

Connector	Wire Seal	Part No.	Kit Contents
Aluminium Receptacle	Green Ring (Normal)	M34-24-91PN	1 x Receptacle (HD34-24-91PN) 1 x Removal Tool (114010) 1 x Removal Tool (114008) 1 x Removal Tool (0411-310-1605) 6 x Pin – Solid (0460-215-16141) 3 x Pin – Solid (0460-204-12141) 3 x Pin – Solid (0460-204-08141) 1 x Cavity Plug (114018) 2 x Cavity Plug (114017) 1 x Panel Nut (112263-90) 1 x Lock Washer (112264)

ionnic.com



Visit website

The screenshot shows the IONNIC website homepage. At the top, there is a navigation bar with links for Home, Lighting, Safety, Electrical, and Contact Us, along with a search bar. The main banner features the TE DEUTSCH logo and the text "IONNIC - AUSTRALIA'S OFFICIAL Deutsch Industrial DISTRIBUTORS". Below the banner are three main product categories: LIGHTING (Products to help you see or be seen from IONNIC, Nordic Lights & Vision Alert), SAFETY (Reverse in safety with bbs-tek® white sound reversing alarms & CCTV systems), and ELECTRICAL (Electrical components & systems from Class1, Schlemmer, Carlingswitch & TE DEUTSCH). The footer includes a footer menu with links for About Us, Terms of Use, Privacy Policy, Product Categories, Catalogues, Reseller Info, Site Search, and a subscription form for product updates.

The screenshot shows the IONNIC website product page for Assortment Kits. The page features a navigation menu on the left with categories like LIGHTING, SAFETY, and ELECTRICAL. The main content area displays a grid of product images for various connector series (DT Series, CAN Network, Assortment Kits, DT Detector, DTV Series, DTM Series, DTP Series, DTHD Series, HD10 Series, HD30 / HDP20 Series, Contacts, Bussed Connectors, Crimping Tools, Contact Removal Tools). A detailed view of an Assortment Kit is shown, including a list of features such as "604 piece workshop kit containing assortments of DT Series connectors & contacts" and "Includes crimp tool and multi-use removal tool". The page also includes a specifications section, associations, and catalogue downloads. The footer is identical to the homepage screenshot.

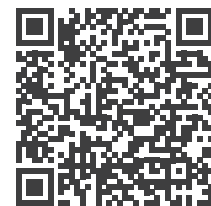

Check out the entire range of TE DEUTSCH

The IONNIC website – for all the most up to date products and info